

Über 140 Bordwandprofile im Programm mit folgenden Eigenschaften:



Materialdicke: von 1,25 bis 3,50 mm



Längen: von 1000 bis 6700 mm



Höhe: von 400 bis 1000 mm
aus einem Stück
Weitere Höhen auf Anfrage.



Besonders geeignet für:
Nutzfahrzeuge und landwirtschaftliche
Fahrzeuge

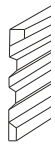

Hohe Stabilität der Bordwandprofile dank neuer Konstruktion und Ausführungen

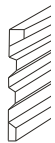

Schutz vor Feuchtigkeit und Erhöhung der Stabilität durch durchgehende Laserschweißnaht

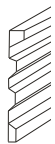

Fertigung nach geltenden Toleranzen
DIN 59413 und 17100

Erläuterung der Bezeichnungen:

P = Bordwandprofile für Grundbordwände (untere)

PDL-A = Bordwandprofile für Grundbordwände (untere) jedoch mit Aussennase

PDL-I = Bordwandprofile für Aufsatzbordwände (obere) jedoch mit Innennase

Beispiele für Bordwandbezeichnungen:

P 500/60/33 TS

PDL-A 600/33/33 TSFS

PDL-I 800/60/33 2TS

Ausschnitte und Einzelheiten

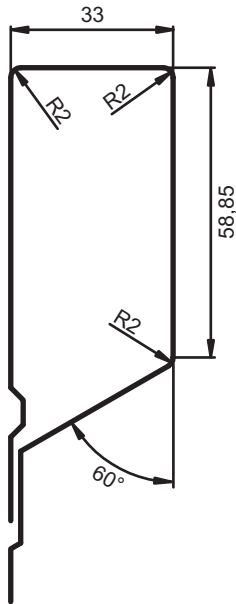
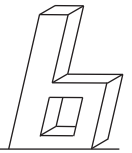

Kastenhöhe 33 mm

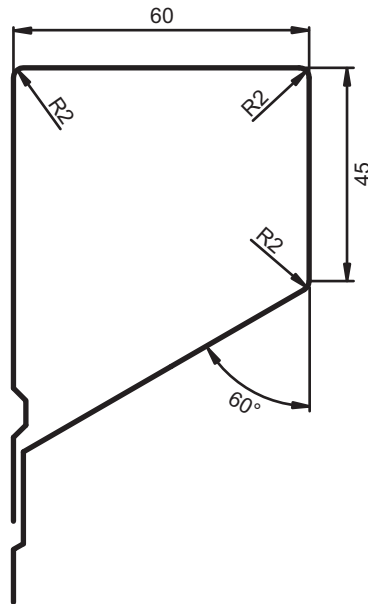

Kastenhöhe 60 mm

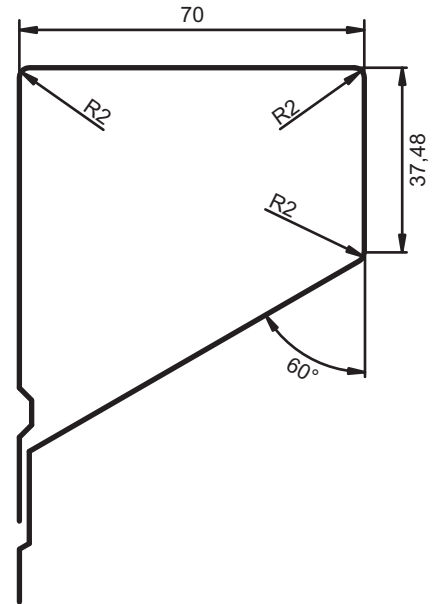

Kastenhöhe 70 mm

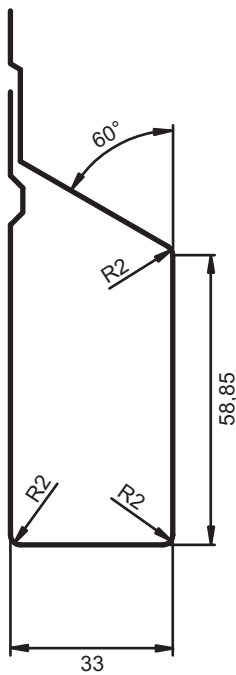

P- Kasten
Kastenhöhe 33 mm

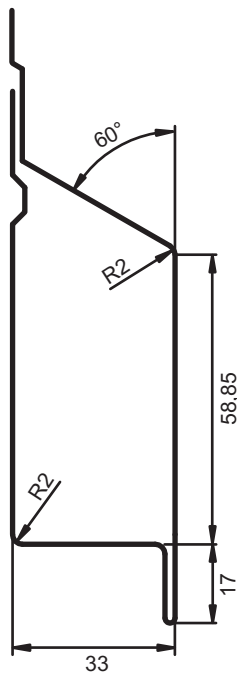

PDL-A - Kasten
Dichtleiste Aussen Unterwand

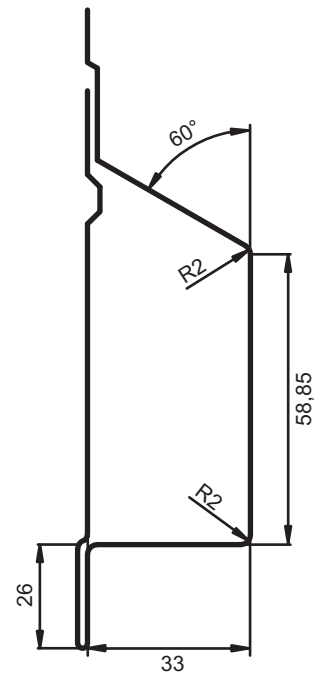

PDL-I - Kasten
Dichtleiste Innen Aufsatzwand

Ausschnitte und Einzelheiten

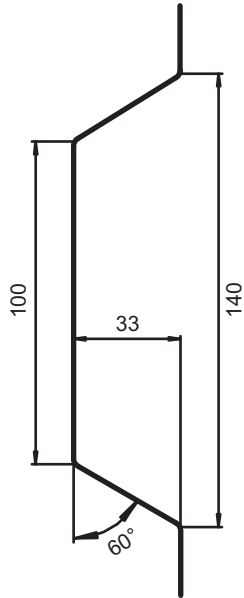
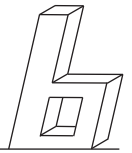

TS - Sicke
Trapezsicke

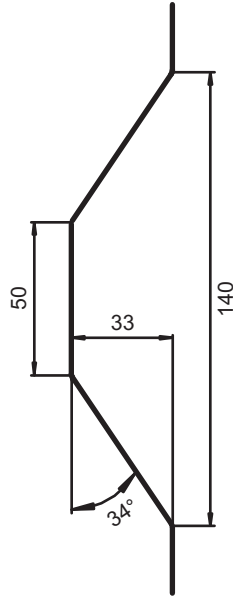

FS - Sicke
Flachsicke

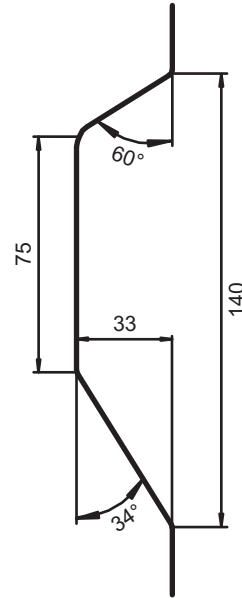

TS FS - Sicke

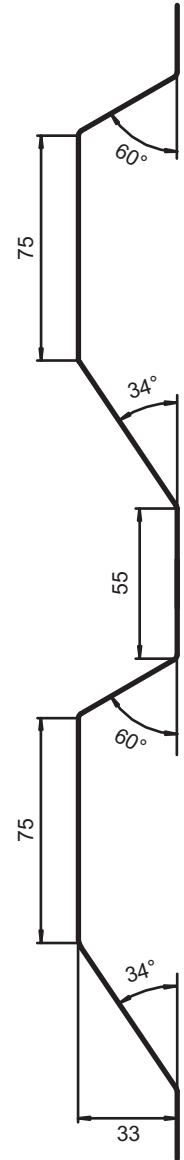

2 TS FS - Sicken

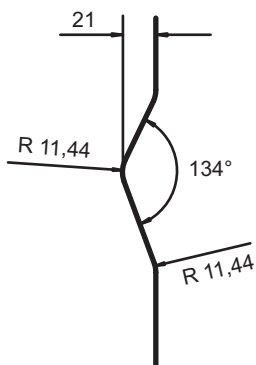

VS - Sicke

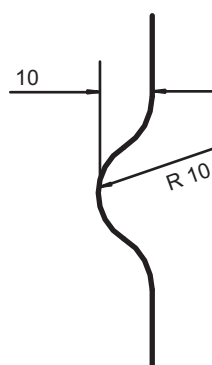

NS - Sicke
Normalsicke

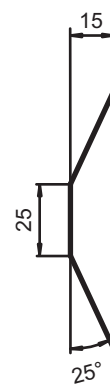

FS - Sicke klein
Flachsicke klein

Höhe: 400 mm

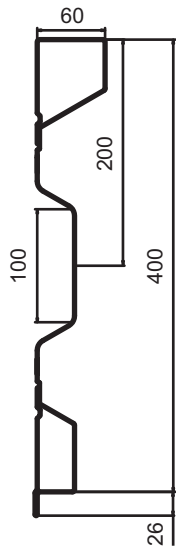
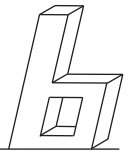

PDL-I 400/60/33 TS

Blechdicke Kg/m
S=2,0 mm 12,52

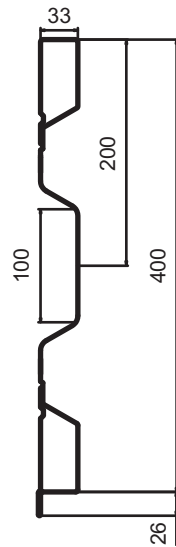

PDL-I 400/33/33 TS

Blechdicke Kg/m
S=2,0 mm 11,84

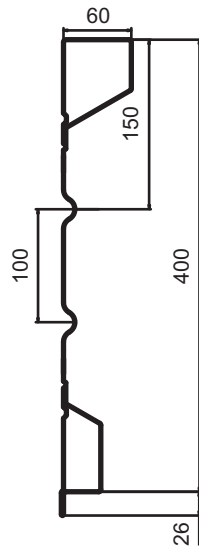

PDL-I 400/60/33 NS

Blechdicke Kg/m
S=2,0 mm 12,52

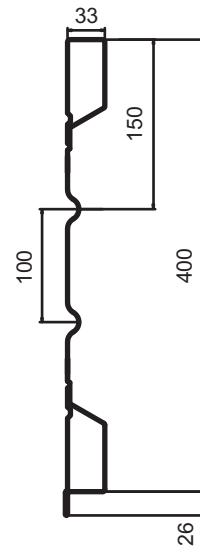

PDL-I 400/33/33 NS

Blechdicke Kg/m
S=2,0 mm 11,47

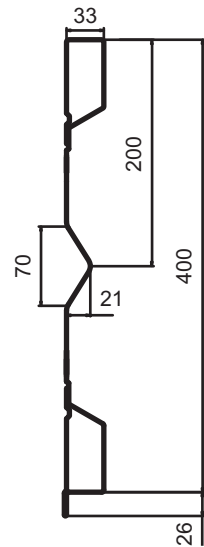

PDL-I 400/33/33 VS

Blechdicke Kg/m
S=2,0 mm 11,50

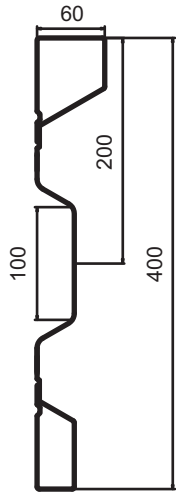

P 400/60/33 TS

Blechdicke Kg/m
S=2,0 mm 11,74

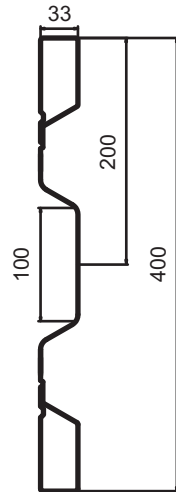

P 400/33/33 TS

Blechdicke Kg/m
S=2,0 mm 11,09

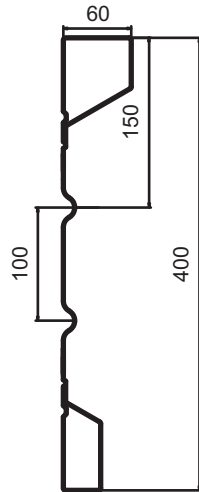

P 400/60/33 NS

Blechdicke Kg/m
S=2,0 mm 11,41

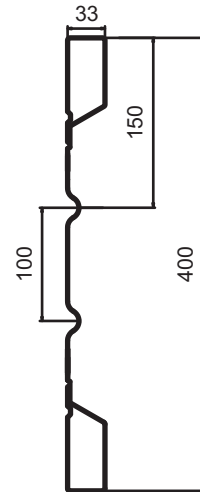

P 400/33/33 NS

Blechdicke Kg/m
S=2,0 mm 10,70
S=1,5 mm 8,10
S=1,25 mm 6,75

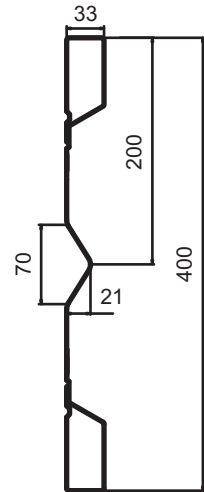

P 400/33/33 VS

Blechdicke Kg/m
S=2,0 mm 10,70

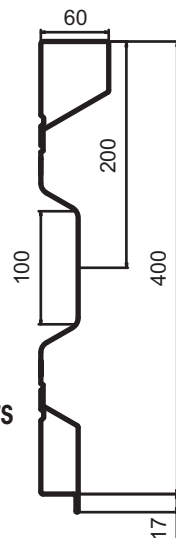

PDL-A 400/60/33 TS

Blechdicke Kg/m
S=2,0 mm 12,52

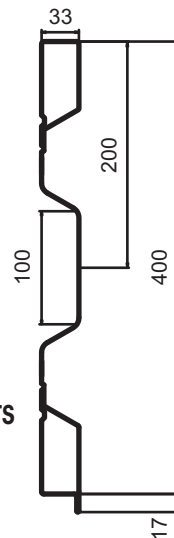

PDL-A 400/33/33 TS

Blechdicke Kg/m
S=2,0 mm 11,84

Höhe: 500 mm

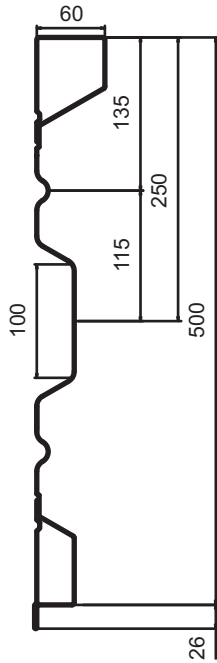
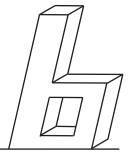

PDL-I 500/60/33 TS

Blechdicke Kg/m
S=2,0 mm 14,16

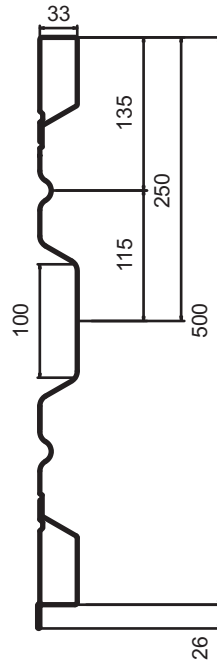

PDL-I 500/33/33 TS

Blechdicke Kg/m
S=2,0 mm 13,52

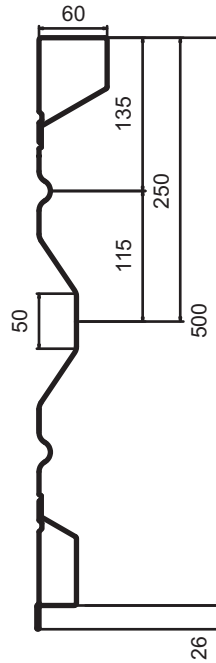

PDL-I 500/60/33 FS

Blechdicke Kg/m
S=2,0 mm 13,82

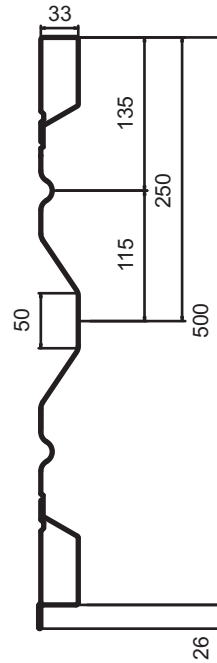

PDL-I 500/33/33 FS

Blechdicke Kg/m
S=2,0 mm 12,95

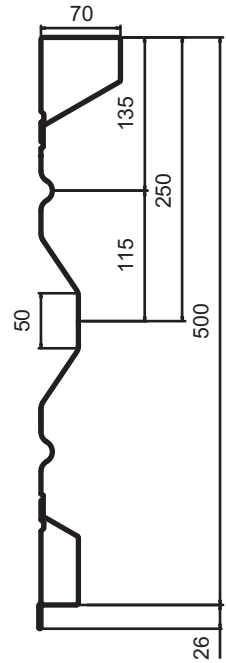

PDL-I 500/70/33 FS

Blechdicke Kg/m
S=2,0 mm 14,48
S=2,5 mm 17,85

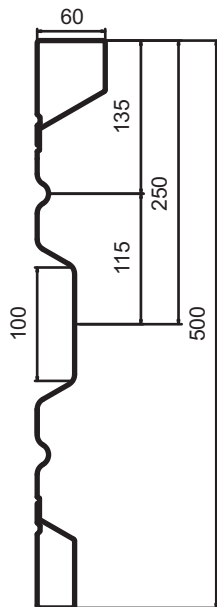

P 500/60/33 TS

Blechdicke Kg/m
S=2,0 mm 13,38
S=2,5 mm 16,70

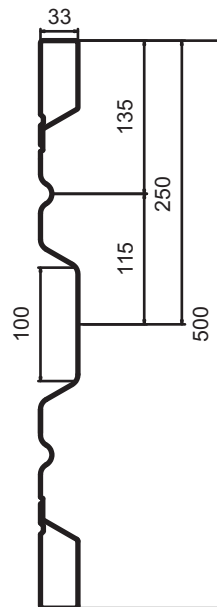

P 500/33/33 TS

Blechdicke Kg/m
S=2,0 mm 12,77

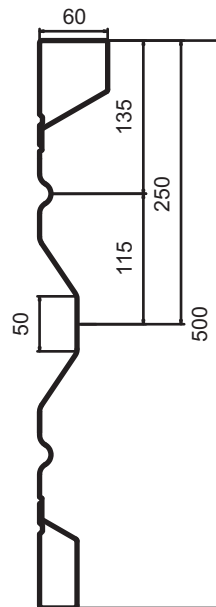

P 500/60/33 FS

Blechdicke Kg/m
S=2,0 mm 12,95
S=2,5 mm 16,19

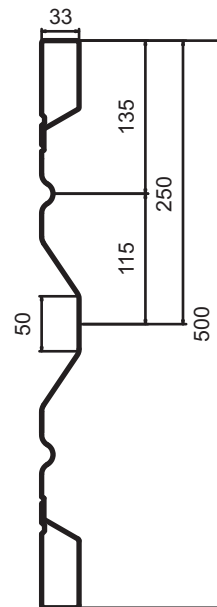

P 500/33/33 FS

Blechdicke Kg/m
S=1,5 mm 9,42
S=2,0 mm 12,40

Höhe: 500 mm

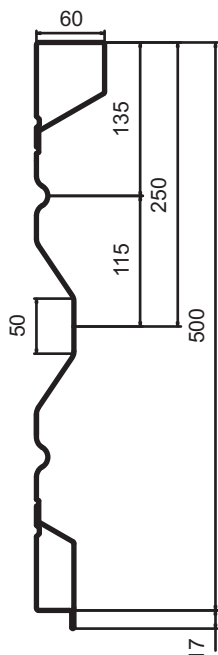

PDL-A 500/60/33 FS

Blechdicke	Kg/m
S=2,0 mm	13,83
S=2,5 mm	17,60

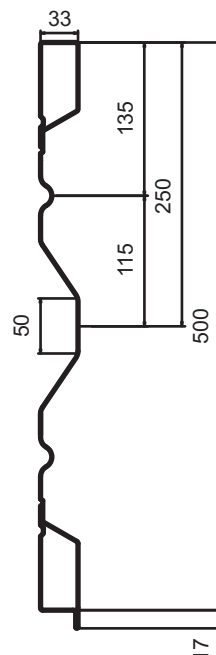

PDL-A 500/33/33 FS

Blechdicke	Kg/m
S=2,0 mm	12,95

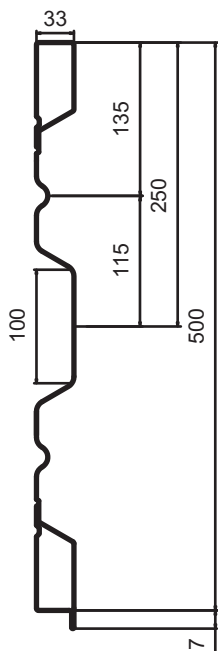

PDL-A 500/33/33 TS

Blechdicke	Kg/m
S=2,0 mm	13,52
S=2,5 mm	16,70

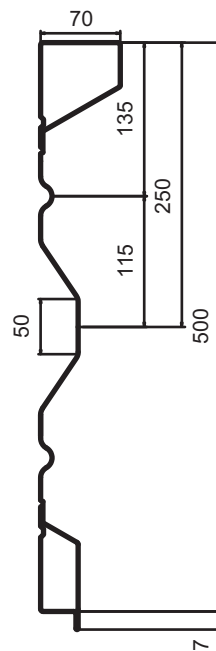

PDL-A 500/70/33 FS

Blechdicke	Kg/m
S=2,0 mm	14,48
S=2,5 mm	17,85

Höhe: 600 mm

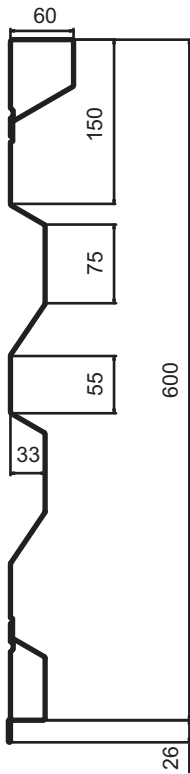
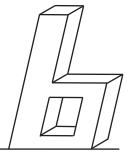

PDL-I 600/60/33 TSFS

Blechdicke Kg/m
 S=2,0 mm 16,20
 S=2,5 mm 20,20

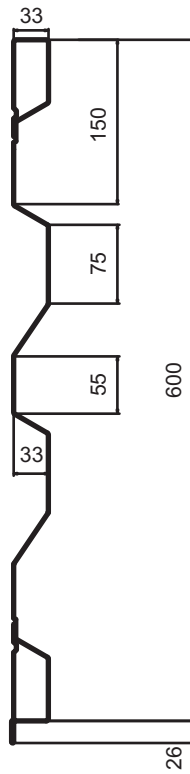

PDL-I 600/33/33 TSFS

Blechdicke Kg/m
 S=2,0 mm 15,68

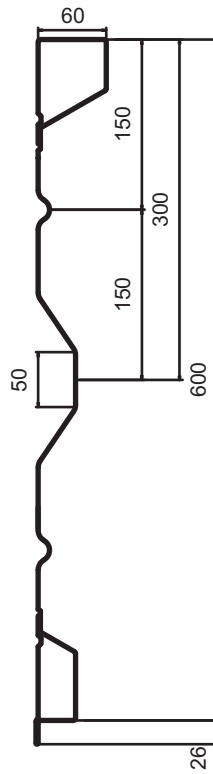

PDL-I 600/60/33 FS

Blechdicke Kg/m
 S=2,0 mm 16,39
 S=2,5 mm 19,24

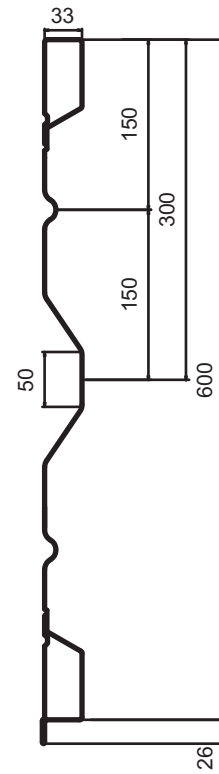

PDL-I 600/33/33 FS

Blechdicke Kg/m
 S=2,0 mm 14,63

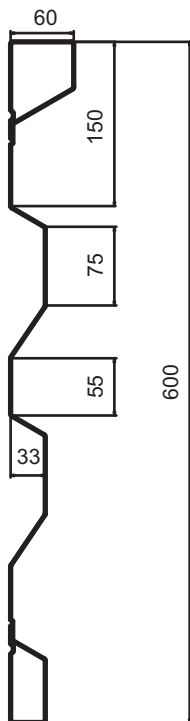

P 600/60/33 TSFS

Blechdicke Kg/m
 S=2,0 mm 15,12
 S=2,5 mm 18,94 QSTE 380
 S=3,0 mm 22,71 QSTE 380
 durchgehend verschweißt

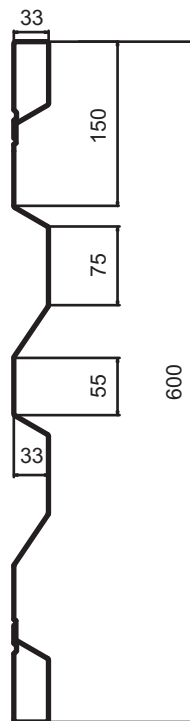

P 600/33/33 TSFS

Blechdicke Kg/m
 S=2,0 mm 14,88

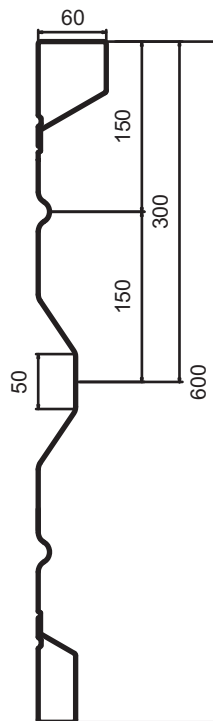

P 600/60/33 FS

Blechdicke Kg/m
 S=2,0 mm 14,75
 S=2,5 mm 18,16

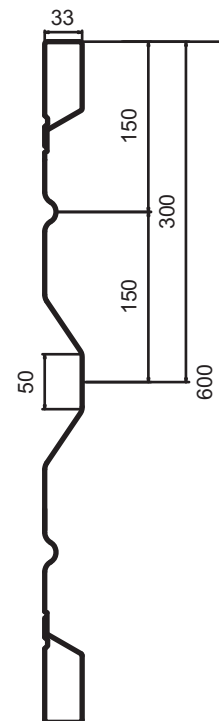

P 600/33/33 FS

Blechdicke Kg/m
 S=2,0 mm 13,97

Höhe: 600 mm

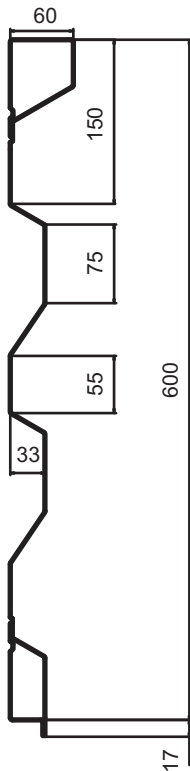
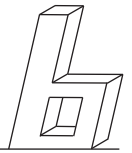

PDL-A 600/60/33 TSFS

Blechdicke	Kg/m
S=2,0 mm	16,20
S=2,5 mm	20,20

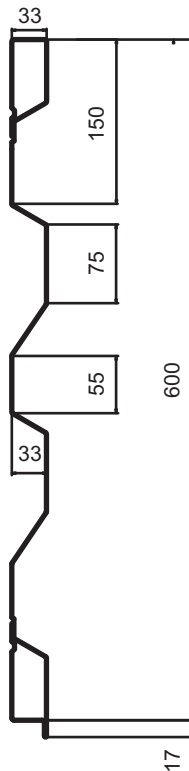

PDL-A 600/33/33 TSFS

Blechdicke	Kg/m
S=2,0 mm	15,68
S=2,5 mm	18,94

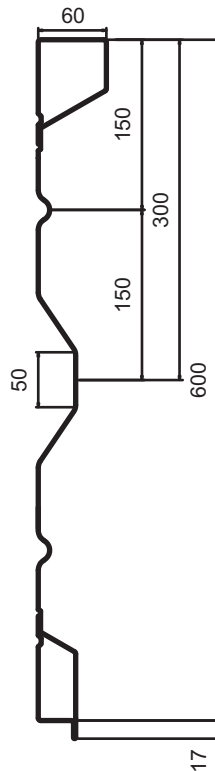

PDL-A 600/60/33 FS

Blechdicke	Kg/m
S=2,0 mm	16,39
S=2,5 mm	19,24

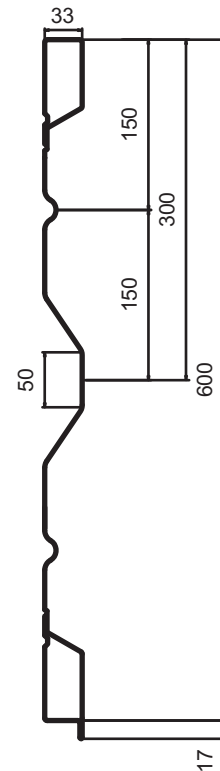

PDL-A 600/33/33 FS

Blechdicke	Kg/m
S=2,0 mm	14,63

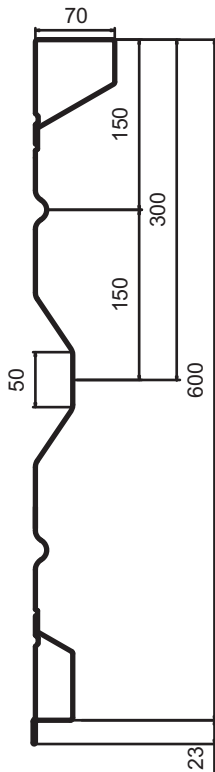

PDL-I 600/70/33 FS

Blechdicke	Kg/m
S=2,0 mm	17,92
S=2,5 mm	19,24

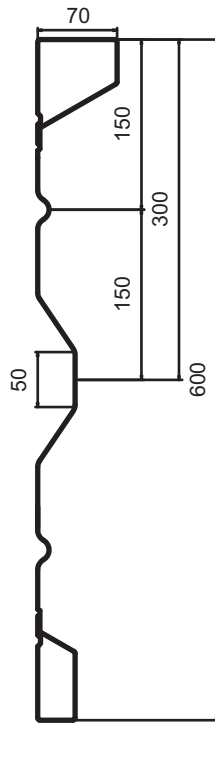

P 600/70/33 FS

Blechdicke	Kg/m
S=2,0 mm	15,04
S=2,5 mm	18,85

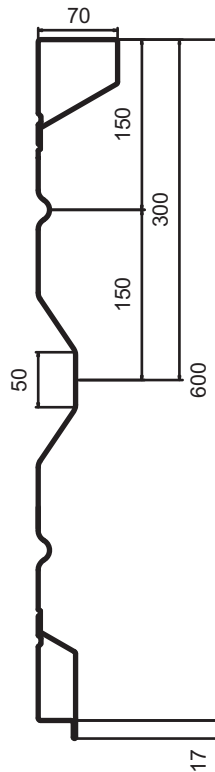

PDL-A 600/70/33 FS

Blechdicke	Kg/m
S=2,0 mm	17,92
S=2,5 mm	19,24

Höhe: 800 mm

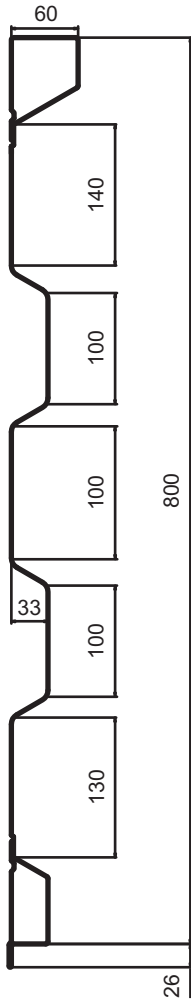
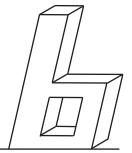

PDL-I 800/60/33 2TS

Blechdicke	Kg/m
S=2,0 mm	19,52
S=2,5 mm	24,40

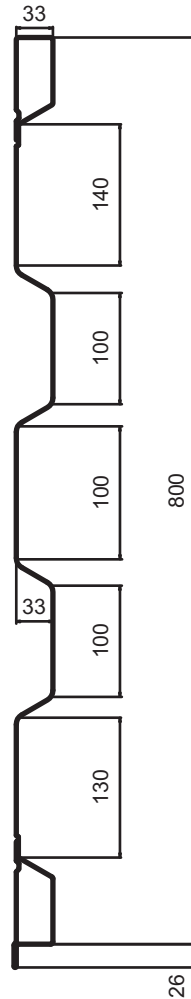

PDL-I 800/33/33 2TS

Blechdicke	Kg/m
S=2,0 mm	18,88
S=2,5 mm	23,40

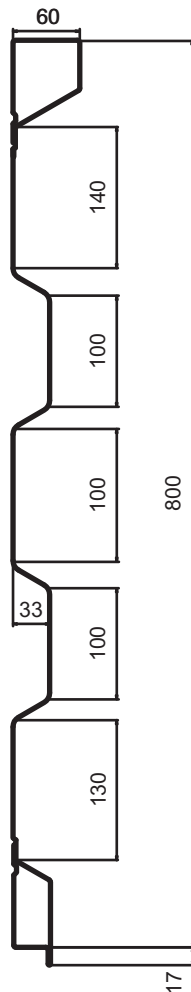

PDL-A 800/60/33 2TS

Blechdicke	Kg/m
S=2,5 mm	24,36

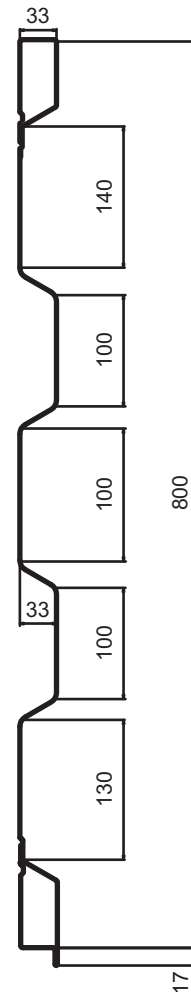

PDL-A 800/33/33 2TS

Blechdicke	Kg/m
S=2,0 mm	18,88
S=2,5 mm	22,60

Höhe: 800 mm

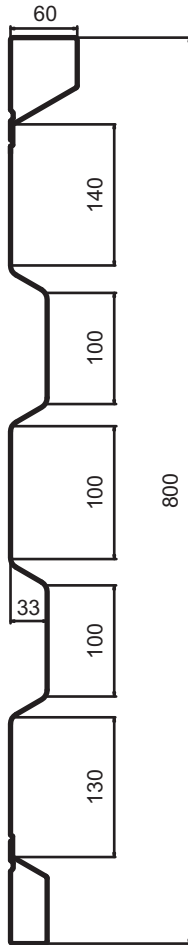
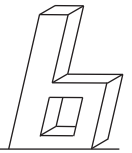

P 800/60/33 2TS

Blechdicke	Kg/m
S=2,0 mm	18,64
S=2,5 mm	23,60 QSTE 380
S=3,0 mm	27,44 QSTE 380

durchgehend verschweißt

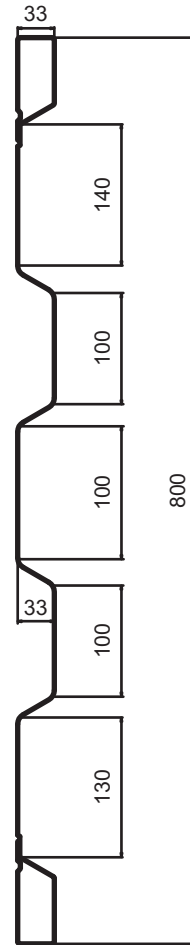

P 800/33/33 2TS

Blechdicke	Kg/m
S=2,0 mm	18,32
S=2,5 mm	22,60

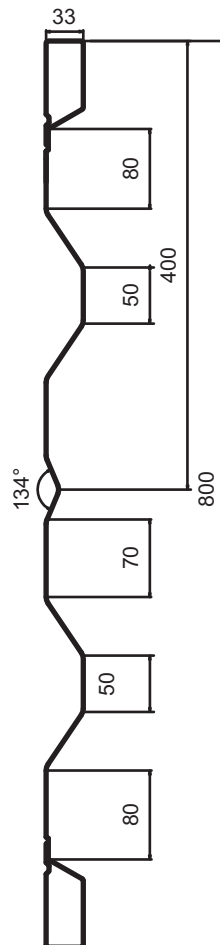

P 800/33/33 2FSVS

Blechdicke	Kg/m
S=1,5 mm	13,54 QSTE 380
S=2,0 mm	18,32

Höhe: 940 mm und 1000 mm

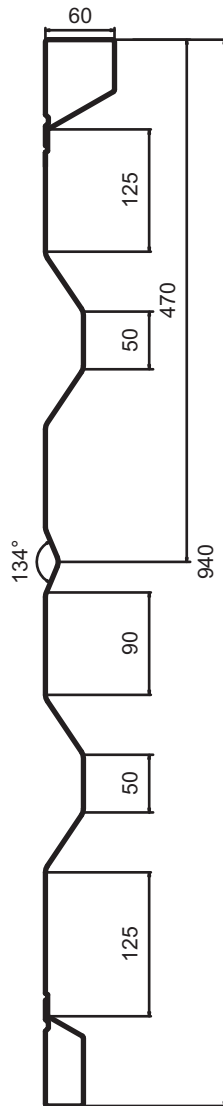
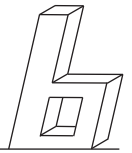

P 940/60/33 2FSVS

Blechdicke Kg/m
S=2,5 mm 25,98

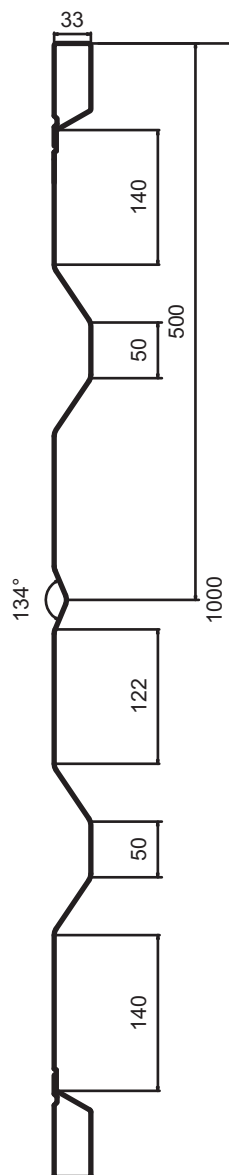

P 1000/33/33 2FSVS

Blechdicke Kg/m
S=2,0 mm 20,38
S=2,5 mm 25,98
S=3,0 mm 31,16 QSTE 380

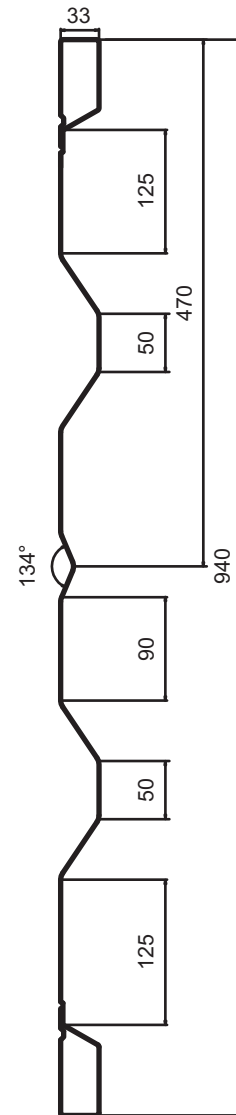

P 940/33/33 2FSVS

Blechdicke Kg/m
S=1,5 mm 15,17

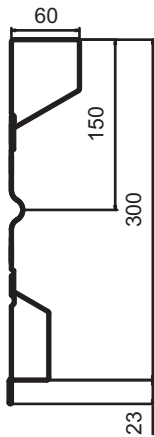
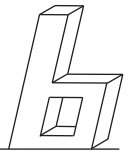

PDL-I 300/60/33 NS

Blechdicke Kg/m
S=2,0 mm 10,70

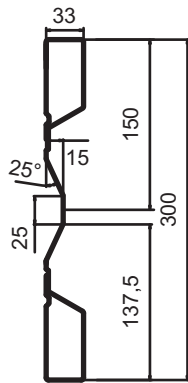

P 300/33/33 FS

Blechdicke Kg/m
S=1,25 mm 5,69
S=2,0 mm 9,11

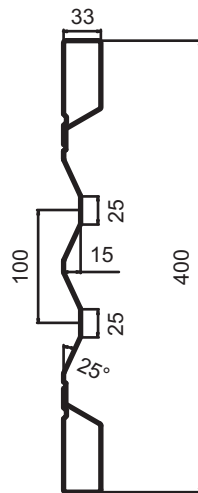

P 400/33/33 2FS

Blechdicke Kg/m
S=1,25 mm 6,75
S=1,5 mm 8,10
S=2,0 mm 10,70

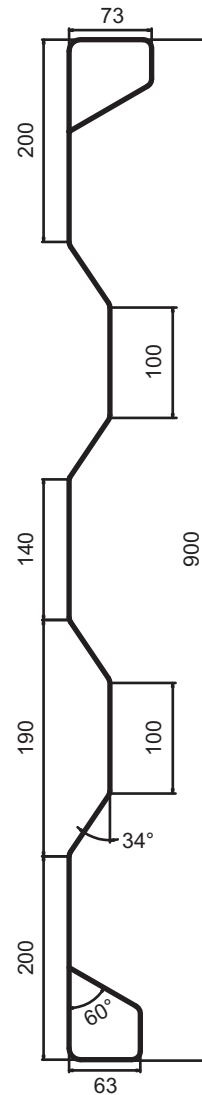

P 900/70/60 2FS groß

Blechdicke Kg/m
S=3,5 mm 36,40 QSTE 380

Weitere Sonderprofile sind die doppelwandigen Bordwände!!!

Einzelheiten über die doppelwandigen Bordwände

Bei den doppelwandigen Bordwänden handelt es sich um Standardprofile, die mit einem Innenblech verschweißt sind.

Der Kunde hat die Möglichkeit gegen Aufpreis die Blechdicke und die Materialqualität des Innenbleches selbst zu bestimmen.

Durch den Einsatz der Standardprofile und die freie Wahl des Innenbleches ist diese Lösung für unsere Kunden nicht nur sehr flexibel sondern auch kostengünstig.

Lagerlängen

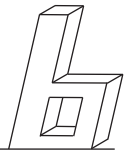

Profilbezeichnung	Lagerlängen																								
	1800	1900	2000	2100	2200	2300	2400	2500	3000	3200	3400	3600	3805	4005	4205	4505	4805	5005	5205	5505	6005	6305	6505	6705	
PDL-I 400/33/33 NS 2,0	X	X	X	X								X	X	X	X	X	X					X			X
PDL-I 400/60/33 NS 2,0												X	X	X	X	X	X					X			X
PDL-I 400/33/33 TS 2,0	X	X	X	X	X							X	X	X	X	X	X					X			X
PDL-I 400/60/33 TS 2,0											X	X	X	X	X	X	X					X			X
PDL-I 500/33/33 TS 2,0	X	X	X	X	X	X	X					X	X	X	X	X	X					X			X
PDL-I 500/60/33 TS 2,0								X	X			X	X	X	X	X	X					X			X
PDL-I 600/33/33 TSFS 2,0				X	X	X	X	X				X	X	X	X	X	X					X			X
PDL-I 600/60/33 TSFS 2,0						X	X	X				X	X	X	X	X	X					X			X
PDL-I 600/60/33 TSFS 2,5					X	X	X	X				X	X	X	X	X	X					X			X
PDL-I 800/33/33 2TS 2,0				X	X	X	X	X				X	X	X	X	X	X					X			X
PDL-I 800/33/33 2TS 2,5					X	X	X	X				X	X	X	X	X	X					X			X
PDL-I 800/60/33 2TS 2,0						X	X	X				X	X	X	X	X	X					X			X
PDL-I 800/60/33 2TS 2,5						X	X	X				X	X	X	X	X	X					X			X
PDL-A 400/33/33 TS 2,0												X	X	X	X	X	X					X			X
PDL-A 400/60/33 TS 2,0												X	X	X	X	X	X					X			X
PDL-I 500/33/33 FS 2,0			X	X	X	X	X											X	X						X
PDL-I 500/60/33 FS 2,0								X										X	X						X
PDL-I 500/70/33 FS 2,0																		X	X						X
PDL-I 500/70/33 FS 2,5																		X	X						X
PDL-I 600/33/33 FS 2,0				X	X	X	X	X										X	X						X
PDL-I 600/70/33 FS 2,0																		X	X						X
PDL-I 600/70/33 FS 2,5																		X	X						X
PDL-A 500/33/33 FS 2,0					X	X	X	X										X	X						X
PDL-A 500/60/33 FS 2,0																		X	X						X
PDL-A 500/70/33 FS 2,0																		X	X						X
PDL-A 500/70/33 FS 2,5																		X	X						X
PDL-A 600/70/33 FS 2,5																		X	X						X
PDL-A 600/33/33 2TSFS 2,0				X	X	X	X	X										X	X						X
PDL-A 600/60/33 2TSFS 2,0																		X	X						X
PDL-A 800/33/33 2TSFS 2,5						X	X	X										X	X						X
PDL-A 800/60/33 2TSFS 2,5						X	X	X										X	X						X

Alle Bordwände können nach Ihren Angaben zugeschnitten werden.
Berechnet wird die eingesezte Länge.

ACHTUNG!!! Nicht alle Lagerlängen sind immer verfügbar!!!!

Lagerlängen

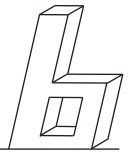

Profilbezeichnung	Lagerlängen																								
	1800	1900	2000	2100	2200	2300	2400	2500	3000	3200	3400	3600	3805	4005	4205	4505	4805	5005	5205	5505	6005	6305	6505	6705	
P 400/33/33 VS 2,0																			X			X			X
P 400/33/33 2FS 1,50																						X			X
P 400/33/33 2FS 2,0																						X			X
P 400/33/33 NS 1,25																						X			X
P 400/33/33 NS 1,50																						X			X
P 400/33/33 NS 2,0		X	X	X								X	X	X	X	X	X	X				X			X
P 400/60/33 NS 2,0												X	X	X	X	X	X	X				X			X
P 400/33/33 TS 2,0	X	X	X	X	X							X	X	X	X	X	X	X				X			X
P 400/60/33 TS 2,0		X	X	X	X						X	X	X	X	X	X	X	X				X			X
P 500/33/33 TS 2,0		X	X	X	X	X	X					X	X	X	X	X	X	X				X			X
P 500/60/33 TS 2,0												X	X	X	X	X	X	X				X			X
P 500/60/33 TS 2,5												X	X	X	X	X	X	X				X			X
P 600/33/33 2TFS 2,0						X	X	X											X	X	X				X
P 600/60/33 2TFS 2,0							X	X	X										X	X	X				X
P 600/60/33 2TFS 2,5 QSTE							X	X	X										X	X	X				X
P 600/60/33 2TFS 3,0 DS QSTE																			X	X	X				X
P 800/33/33 2TS 2,0						X	X	X											X	X	X				X
P 800/33/33 2TS 2,5						X	X	X											X	X	X				X
P 800/60/33 2TS 2,5						X	X	X											X	X	X				X
P 800/60/33 2TS 3,0 DS								X											X	X	X				X
P 500/33/33 FS 1,5																						X			X
P 500/33/33 FS 2,0		X	X	X	X							X	X	X	X	X	X	X				X			X
P 500/60/33 FS 2,0																			X	X	X				X
P 500/60/33 FS 2,5																			X	X	X				X
P 600/33/33 FS 2,0						X	X	X											X	X	X				X
P 800/33/33 2FVS 1,5																			X	X	X				X
P 800/33/33 2FVS 2,0						X	X	X											X	X	X				X
P 900/70/60 2FVS 3,5 DS QSTE							X	X											X	X	X				X
P 940/33/33 2FVS 2,5							X	X											X	X	X				X
P 1000/33/33 2FVS 2,0						X	X	X											X	X	X				X
P 1000/33/33 2FVS 2,5						X	X	X											X	X	X				X

Alle Bordwände können nach Ihren Angaben zugeschnitten werden.
Berechnet wird die eingesezte Länge.

ACHTUNG!!! Nicht alle Lagerlängen sind immer verfügbar !!!!!



Art der Toleranz	Zulässige bzw. Vereinbarte Abweichungen
Länge	+/- 1,00 mm; jedoch nicht schlechter als DIN-NORM 59 413
Breite	+/- 1,00 mm; jedoch nicht schlechter als DIN-NORM 59 413 (das Bordwandprofil muss 250 mm von der Schnittkante gemessen werden.)
Rechtwinkligkeit	0,00 - 0,5° x Bordwandhöhe; jedoch nicht schlechter als DIN-NORM 59 413 (siehe DIN-Blatt Pkt. 6.4)
Geradheit	0,00 - 0,50 mm; jedoch nicht schlechter als DIN-NORM 59 413 Dabei müssen Faktoren wie z.B. Transport, Verladung, interner Transport, ect. berücksichtigt werden. Die Geradheit der Bordwand ist auch von der Länge dieser abhängig.
Verdrillung	0,00 - 5,00 mm; jedoch nicht schlechter als DIN-NORM 59 413
Kasten	-1,00 - + 1,50 mm; Toleranz im Minusbereich ist nicht möglich.
Andere Maße	+/- 1,50 mm; jedoch nicht schlechter als DIN-NORM 59 413

Weitere Informationen:

Die oben genannten Werte gelten als freiwillige Verbesserung der Qualität und Einschränkung der Toleranzen.

Trotz aller Bemühungen kann es nach Angaben des Maschinenherstellers durch die Bearbeitung im Profilverfahren zu Abweichungen von den o.g. Werten kommen.

Die o.a. Toleranzen gelten bei Umgebungstemperatur zwischen 18 und 23 Grad Celsius. Firma BOWA haftet nicht für den Verzug, der durch Schweißarbeiten oder weitere Bearbeitung an den Profilen entstehen kann.

Aus diesem Grund **behalten wir uns weiter vor**, unsere Profile nach geltenden DIN-NORMEN 59 413 und 17 100 zu fertigen und zu liefern.



bowa Stahlprofil

Zweigniederlassung der **inmet** Stahl GmbH und Co. KG

Robert-Bosch-Str. 4
D- 94447 Plattling

Tel.: +49 (0) 9931 3077

Fax: +49 (0) 9931 5632

Kontakt@bowa-stahlprofil.de

www.bowa-stahlprofil.de

Öffnungszeiten

Montag - Donnerstag	von 08:00 bis 16:30 Uhr
Freitag	von 08:00 bis 12:00 Uhr

Ladezeiten

Montag - Donnerstag	von 08:00 bis 15:00 Uhr
Freitag	von 08:00 bis 12:00 Uhr

Unsere AGB's können Sie auf unserer Homepage unter www.bowa-stahlprofil.de einsehen und downloaden!

Anfrage oder Bestellung

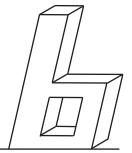

Anfrage

Bestellung

Ihre Anschrift / Ihr Stempel

Artikelbezeichnung	Länge	Menge
--------------------	-------	-------

Anmerkungen:

Bitte faxen Sie diese Seite an +49 (0) 9931 / 56 32